

規格承認書

SPECIFICATION FOR APPROVAL

客戶名稱：
(CUSTOMER)



客戶料號：
(PART NO)

品名規格：
(DESCRIPTION)

DFB402812H

送樣日期：
(SENDING DATE)

2007-12-7

客戶簽章：
SIGNATURE

永林興電子(深圳)有限公司制作

審核：
APPROVED BY:

確認：
CHECKED BY:

作成：
PREPARED BY:

周向阳

吴明峰

周园

敬請“客戶簽章”欄簽核後將零件承認書回傳永林興公司，以便後續作業，謝謝！



永林興科技有限公司
YOUNG LIN TECH CO.,LTD.

致宣電子深圳有限公司
ZHI XUAN ELECTRONICS(SHENZHEN)CO.,LTD.

ISO9001(2000)

ISO14001

CERTIFIED SUPPLIER

<http://www.yltc.cn>

SPECIFICATION FOR APPROVAL

TO: ██████████	SAMPLE ISSUE NO.: YLM00711056-1
MODEL: DFB402812H	SAMPLE ISSUE DATE: 2007-12-7
PART NAME: DC FAN(RoHS)	SAMPLE QTY: 5PCS

REV: 0

1. SCOPE:

THIS SPECIFICATION DEFINES THE ELECTRICAL AND MECHANICAL CHARACTERISTICS OF THE DC BRUSHLESS FAN. THE FAN MOTOR IS WITH TWO PHASES AND FOUR POLES.

2. CHARACTERS:

ITEM	DESCRIPTION
RATED VOLTAGE	12 VDC
OPERATION VOLTAGE	10.8-13.2VDC
STARTING VOLTAGE	9VDC(ON/OFF)
INPUT CURRENT	0.30±10% A
SPEED (10 MINUTE/ ROOM TEMPERATURE 25°C)	10000 RPM±15%
AIR FLOW (AT ZERO STATIC PRESSURE)	12.84CFM
AIR PRESSURE (AT ZERO AIRFLOW)	10.46mmH ₂ O
ACOUSTICAL NOISE (AVG.)	48.45dB-A
SAFETY TYPE	UL CE

(Continued)

Page: 1

YOUNG LIN TECH CO., LTD,

MODEL: DFB402812H

INSULATION STRENGTH	10 MEG OHM MIN. AT 500 VDC (BETWEEN FRAME AND (+) TERMINAL)
DIELECTRIC STRENGTH	5 mA MAX. AT 500 VAC 60 Hz ONE MINUTE, (BETWEEN FRAME AND (+) TERMINAL)
LIFE EXPECTANCE	50,000 HOURS CONTINUOUS OPERATION AT 25°C WITH 15-65 %RH.
ROTATION	WIDDERSHINS VIEW FROM FRAME PLATE SIDE
OVER CURRENT SHUT DOWN	THE CURRENT WILL SHUT DOWN WHEN LOCKING ROTOR.
LEAD WIRE	UL 1007 – AWG #26 BLACK BLACK : (-) RED RED : (+) YELLOW(RD)

NOTES: 1. ALL READINGS ARE MEASURED AFTER STABLY WARMING UP THROUGH 10 MINUTES.

2. THE VALUES WRITTEN IN PARENS, ARE LIMITED SPEC.

3. ACOUSTICAL NOISE MEASURING CONDITION:

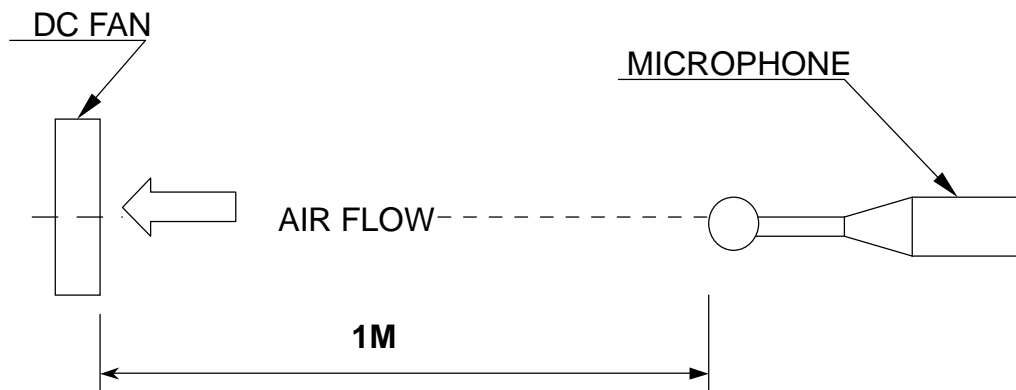

NOISE IS MEASURED AT RATED VOLTAGE IN FREE AIR IN ANECHOIC CHAMBER WITH B & K SOUND LEVEL METER WITH MICROPHONE AT A DISTANCE OF ONE METER FROM THE FAN INTAKE

YOUNG LIN TECH CO., LTD,

MODEL: DFB402812H

3. MECHANICAL:

- 3-1. DIMENSIONS — — — — — SEE DIMENSIONS DRAWING
- 3-2. FRAME — — — — — PLASTIC UL: 94V-0
- 3-3. IMPELLER — — — — — PLASTIC UL: 94V-0
- 3-4. BEARING SYSTEM — — — — — TWO BALL BEARING
- 3-5. WEIGHT — — — — — 37 GRAMS

4. ENVIRONMENTAL:

- 4-1. OPERATING TEMPERATURE — — — — — -10 TO + 70 DEGREE C
- 4-2. STORAGE TEMPERATURE — — — — — -40 TO + 75 DEGREE C
- 4-3. OPERATING HUMIDITY — — — — — 5 TO 90 % RH
- 4-4. STORAGE HUMIDITY — — — — — 5 TO 95% RH

5. PROTECTION:

- 5-1. DROP TEST
IN MINIMUM PACKAGING CONDITION FAN WITHSTANDS EACH ONE
DROP OF THREE FACES FROM 30 CM DISTANCE HEIGHT ONTO 10 MM
THICKNESS OF WOODEN BOARD.
- 5-2. LOCKED ROTOR PROTECTION
IMPEDANCE OF MOTOR WINDING PROTECTS MOTOR FROM FIRE IN 15
MINUTE OF LOCKED ROTOR CONDITION AT THE RATED VOLTAGE.

6. RE OZONE DEPLETING SUBSTANCES;

- 6-1. RESTRICTION SUBSTANCES OF SAMPLE ARE AS FOLLOWS:
Pb(PPM) < 1000 Cd(PPM) < 100 Hg(PPM) < 1000
Cr6+ (PPM) < 1000 PBBs (PPM) < 1000 PBDEs (PPM) < 1000

YLTC	Research & Development Department		
	Approved BY: 周向阳	Checked BY: 吴明峰	Prepared BY: 周园

IMPORTANT NOTES & GENERAL INSTRUCTIONS

1. Any item which is needed to add into specification shall be determined on customer's prior written request. If no information given , fan will be delivered based on our standard judgment.
2. Customer shall confirm the matching and reliability of fan on actual set or unit application.

This include confirmation on set or unit life, electrical noise, mechanical noise, Vibration static electricity ,electric power noise ,drift ,electric resonance between motor and control circuit ,mechanical resonance between motor and chassis, irregular movement of set due to motor noise ,irregular movement of set in strong electromagnetic field ,damaged by lightning surge earthing method etc
3. In order to improve the performance within the scope of specification, parts or material changes are subject to prior notice to customer.
4. Any revisions on the specification shall be done based on mutual discussion and agreement.
5. When any trouble occurs, both parties shall discuss on this specification to solve the matters. In this case, our guarantee is only limited to fans

風扇使用注意事項



HOW TO HANDLE FAN PROPERLY?



1. 取用風扇, 輕取外框兩側, 不可拉扯導線.
1. Hold the fan by frame side. Do not hold lead wires to support the fan.



2. 取用風扇, 不可碰觸或擠壓扇葉與外框.
2. No touching or pressing on the impeller hub. Avoid crushing the frame side.



3. 風扇嚴禁掉落地面, 或敲擊外框任何面.
3. Do not drop on the ground. Do not pound on the frame side.

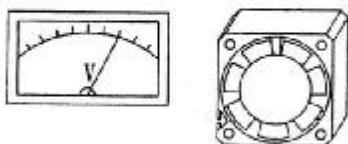

4. 風扇電源需依照規格電壓安裝使用.
4. Connect leads properly and apply voltage according to specification.

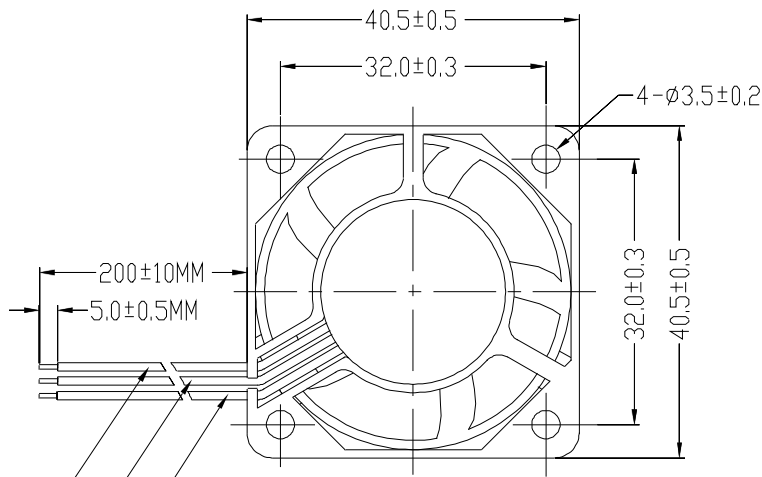

WIRE-YELLOW(U11007-26AWG)

WIRE-RED(U11007-26AWG)

WIRE-BLACK(U11007-26AWG)

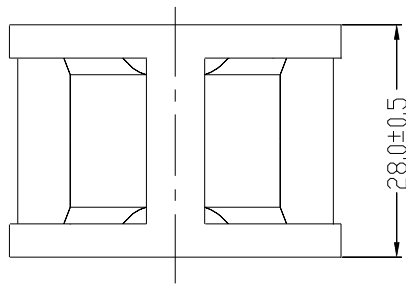
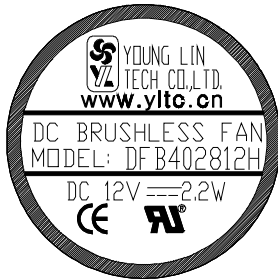

NO.	DESCRIPTION	SPECIFICATION	Q'TY	VENDOR	PART NO.	REMARKS	DESCRIPTION	DC FAN	SCALE	APPD:
							MODEL NO.	DFB402812H	N.T.S	周向阳
							DRAW:	吴明峰		周向阳
										YONG LIN XING ELECTRONICS(SHENZHEN) CO., LTD

Signal Circuit System

R: Alarm/high

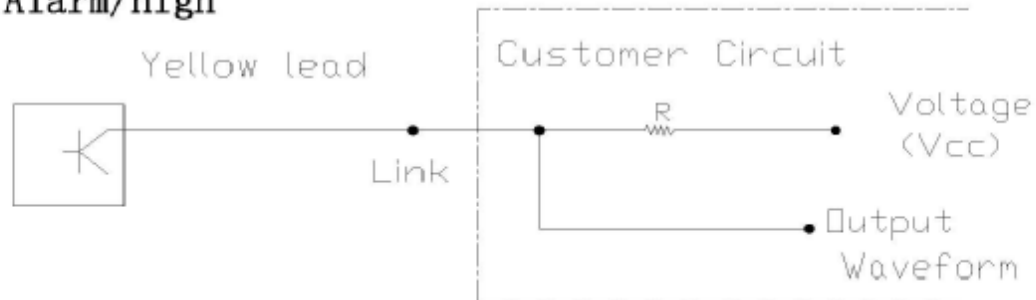

“please select “R”
to make “Link” Less than 10mA”

Vcc:30V Max
Link:10mA Max

Output Waveform

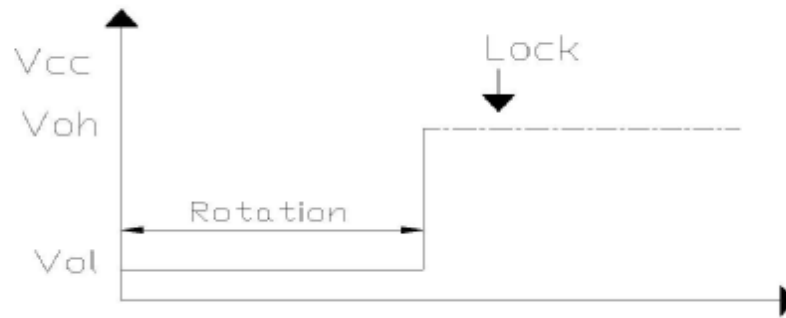

Saturation Voltage $V_{ol}=1.0V$ Max
Release Voltage $V_{oh}=30V$ Max

REVISIONS



DO NOT SCALE DRAWING

UNLESS OTHERWISE SPECIFIED
ALL DIMENSIONS ARE IN MM
TOLERANCES

LINEAR	ANGULAR
.X ±0.1	×. ±0.5
.XX ±0.05	×.X ±0.1

MODEL NO:	SEE SHART	PART NO:	SEE SHART
PART NAME:	Signal Circuit System	FINISH:	
MATERIAL:		DATE:	
SCALE:	1:1	QTY/U:	1
DRAW:	唐自成	CHKD:	吴明峰
		APPD:	周向阳
YONGLINXING ELECTRONICS CO.,LTD			DWG.NO:
			REV: 0