

Approval Sheet for SMD LED

Reference No : T3528HM-203
Version No : Rev 0.0
Customer Name : Standard
Model Name : LFMWW-VF30
Color : White
Issued Date : 14 February. 2011

Customer

Customer					

CTL

CTL					
Eng'ring	Develop.	Prod.	QA	Sales	Approved

Remarks:



358-1. Sin-Dong, Yungtong-Gu, Suwon-Si, Gyeonggi-Do, 442-390
http://www.ctlinc.co.kr **Tel : (031) 205-0450., Fax : (031) 205-5315**

1. Features and Applications

- Package : SMD Package
- Resin : Diffused type
- Dimensions in mm : 3.5 x 2.8 x 1.9 (L x W x H)
- Approx Weight : 35mg
- Technology : InGaN Blue Color
- Viewing Angle : wide (120°)
- Assembly methods : suitable for all SMT assembly methods
- Soldering methods : IR reflow soldering
- Preconditioning : acc. to JEDEC Level 2a
- MSL : Qualified according to JEDEC moisture sensitivity Level 2a.
- Taping : 8mm conductive black carrier tape & antistatic clear cover tape
2,000pcs/reel, Φ180mm wheel
- ESD-withstand voltage : up to 2kV acc. to JESD22-A114-B
- RoHs : Environmental friendly, RoHS compliance.

Applications:

- Outdoor displays
- Backlighting (LCD, switches, keys, displays, illuminated advertising, general lighting)
- Interior automotive lighting (e.g. dashboard backlighting, etc.)
- Indicator

2. Part Name Description

L F M WW – VF 30

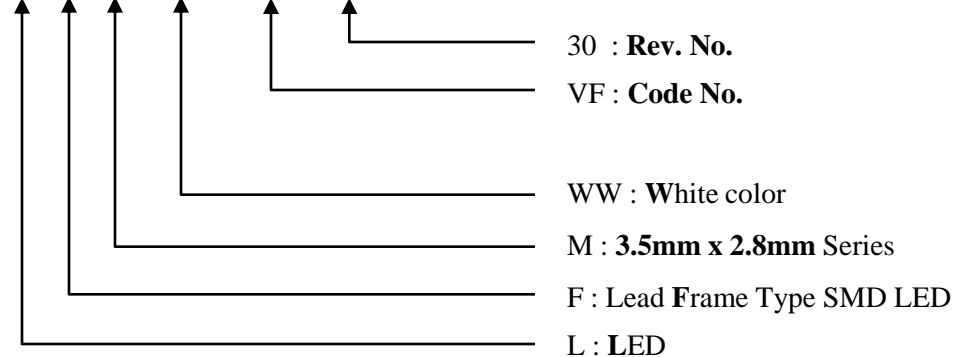

3. Outline Dimensions and Materials

1) Outline Dimensions

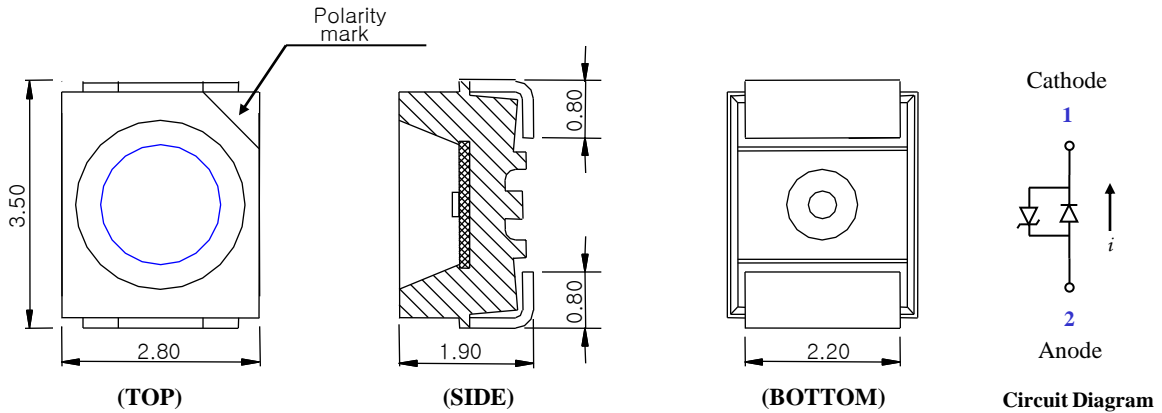

- MODEL : LFMBLZ-xxxx
- TYPE : 3.5 x 2.8 x 1.9 (t)
- TOLERANCE : ± 0.15mm

2) Materials

- Package : Epoxy Resin , Clear (Optional : Diffuser type)
- Paste : Silver filled Epoxy
- Electrode : Ag Plating

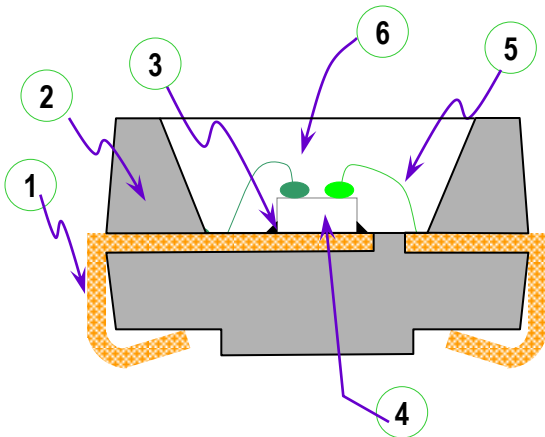

Number	Item	Material
1	Lead	Cu / Ag
2	Pre Mold	PPA
3	Paste	Ag Paste
4	LED Chip	InGaN / Al ₂ O ₃
5	Wire	Gold Wire
6	Epoxy	Clear Epoxy

4. Specifications

1) Absolute Maximum Ratings

Items	Symbol	Maximum Rating	Unit
Forward Current	I_F	20	mA
Pulse Forward Current*	I_{FP}	100	mA
Reverse Voltage	V_R	5	V
Power Dissipation	P_D	70	mW
Operating Temperature	T_{opr}	- 40 ~ 100	°C
Storage Temperature	T_{stg}	- 40 ~ 100	°C

$T_a = 25\text{ °C}$

I_{FP} Conditions : Pulse Width ≤ 0.1 msec. And Duty $\leq 1/10$

2) Initial Electrical / Optical Characteristics

Items	Symbol	Min.	Typ.	Max.	Unit	Condition
Forward Voltage	V_F	2.8	-	3.2		$I_F = 10\text{ mA}$
Luminous Intensity	I_v	500	-	660		$I_F = 10\text{ mA}$
Chromaticity Coordinates	C_x	0.205	-	0.217	-	$I_F = 10\text{ mA}$
	C_y	0.160	-	0.190	-	
Full Width at Half Maximum	$\Delta\lambda$	-	25	-	nm	$I_F = 10\text{ mA}$
Viewing Angle	201/2	-	120	-	Deg.	$I_F = 20\text{ mA}$

Luminous Intensity Measuring Equipment : LX4560A (Teknologue, JAPAN)

Voltages are tested at a current pulse duration 1ms and an accuracy of $\pm 0.1V$

Luminous Intensity is tested at a current pulse duration 5ms and an accuracy of $\pm 10\%$

Dominant Wavelength is tested at a current pulse duration 5ms and an accuracy of $\pm 1\text{ nm}$

5. Grouping parameter

1) Chromaticity Coordinates Ranks

(Ta = 25 °C)

Color Rank	Color Name	Color Coordinates				Test Condition
A	VF30	X	0.205	0.205	0.217	IF = 10 mA
		Y	0.160	0.180	0.190	

0.01 tolerance for Color Coordinates may be caused by measurement inaccuracy.

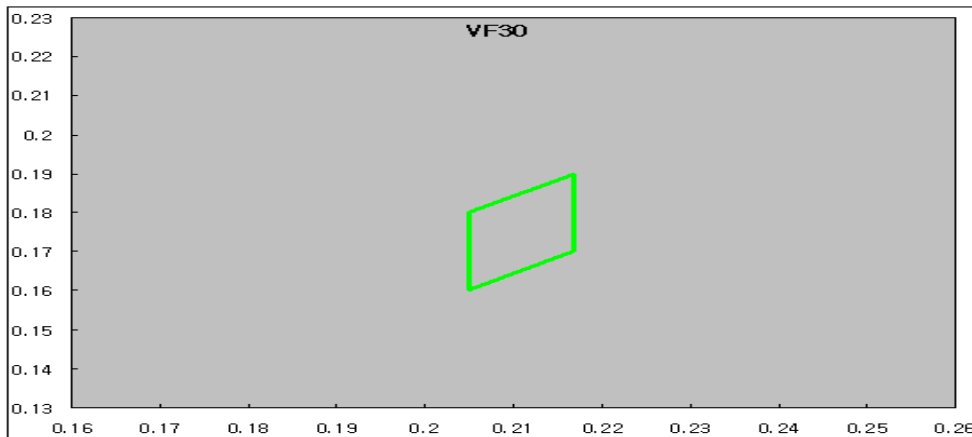

2) Forward Voltage

(Ta = 25 °C)

VF Rank	Min	Typ	Max	Unit	Test Condition
A	2.8	-	3.2	V	IF = 10 mA

Voltages are tested at a current pulse duration 1ms and an accuracy of ±0.1V

3) Luminous Intensity Ranks

(Ta = 25 °C)

IV Rank	Min	Typ	Max	Unit	Test Condition
1	500	-	575	mcd	IF = 10 mA
2	575	-	660		

Luminous Intensity is tested at a current pulse duration 5ms and an accuracy of ±10%

6. Typical Characteristic Curve

Fig.1 Maximum forward current vs. temperature

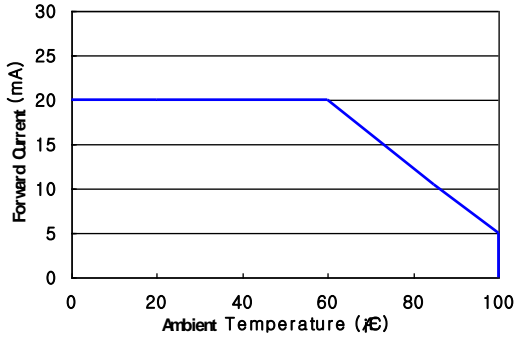

Fig.2 Forward current vs. Luminous Intensity

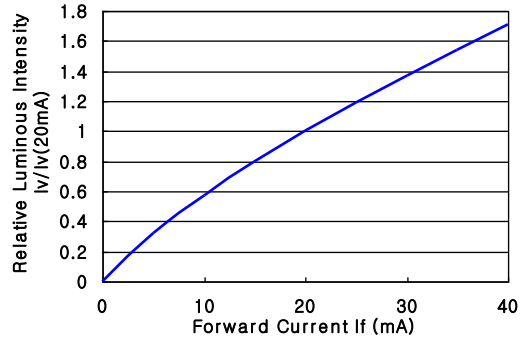

Fig.3 Wavelength Distribution

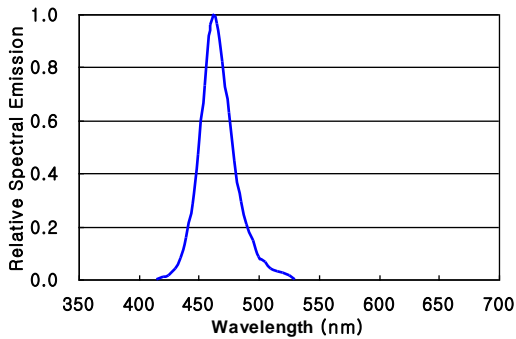

Fig.4 Forward voltage vs. Forward current

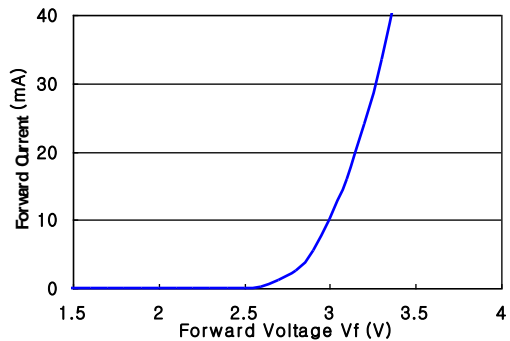

Fig.5 Dominant Wavelength

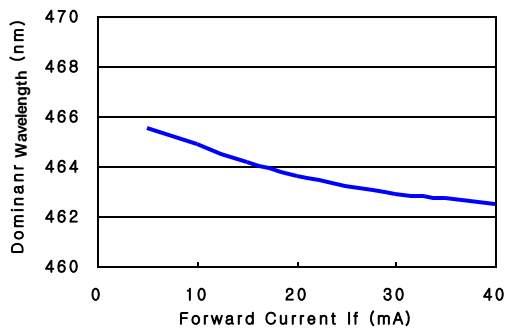
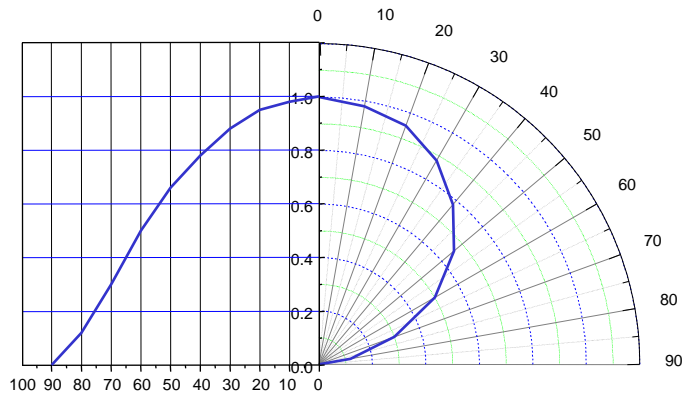

Fig.6 Radiation Diagram



7. Soldering Conditions

Reflow soldering is recommended, and soldering should not be done more than two times. When repairing is done, a double-headed soldering iron should be used.

1) SnPb Eutectic Solder Re-flow Profile (JEDEC J-STD-020C).

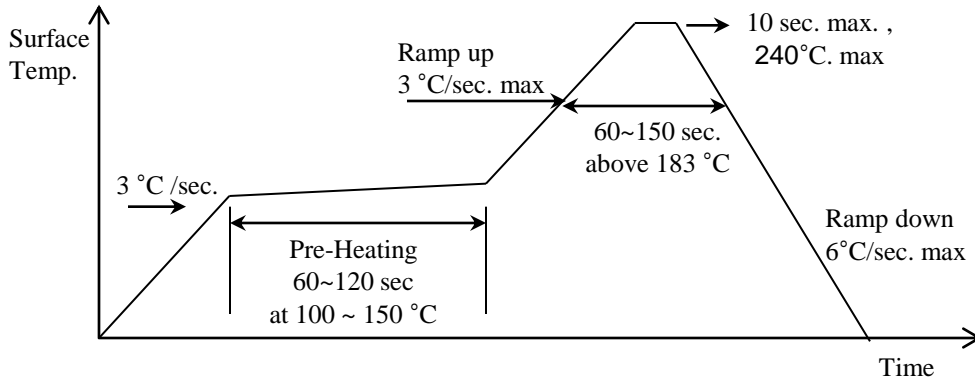

2) Lead-free Solder Re-flow Profile (JEDEC J-STD-020C).

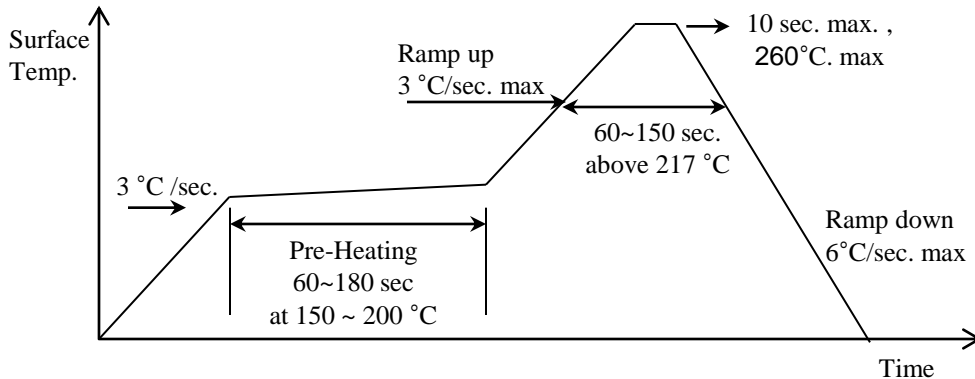

3) Solder Dip Profile

The Immersion of leads into a solder bath @MAX260 °C shall be to 5 seconds max.

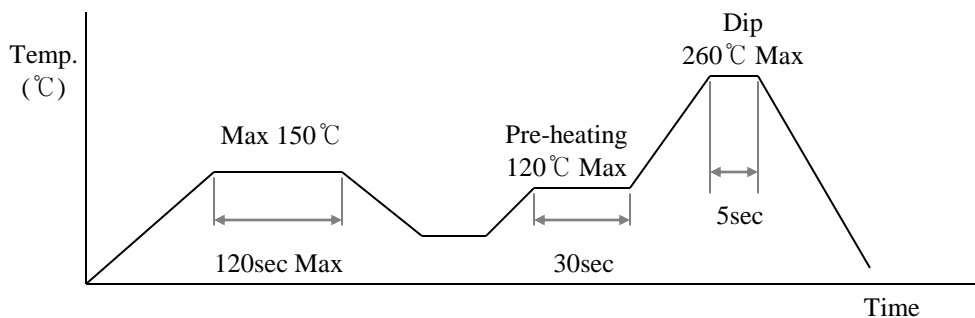

4) Double Wave Soldering Profile

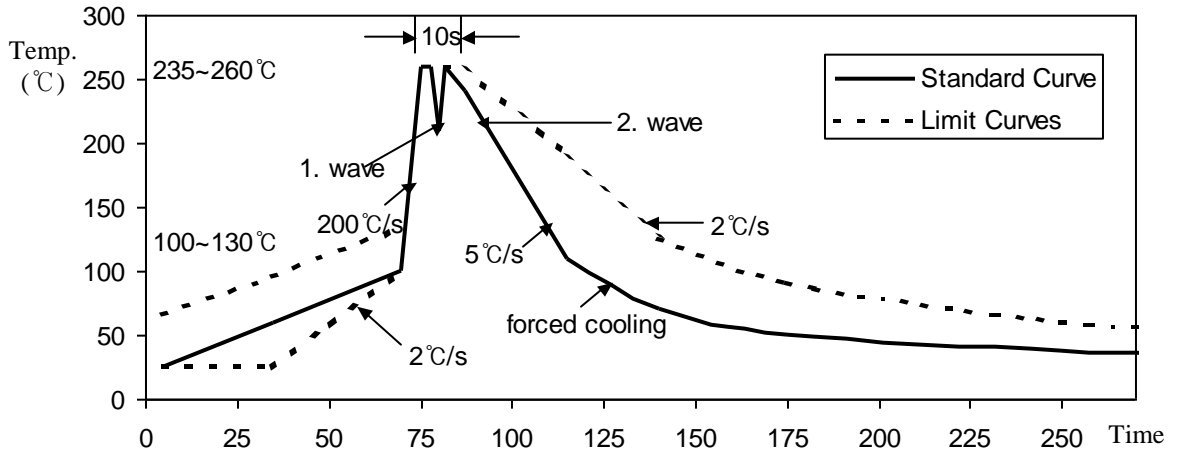

5) For manual solder

Not more than 5sec @max 300°C, under soldering iron.

6) Recommendable Soldering Pattern (for reflow soldering)

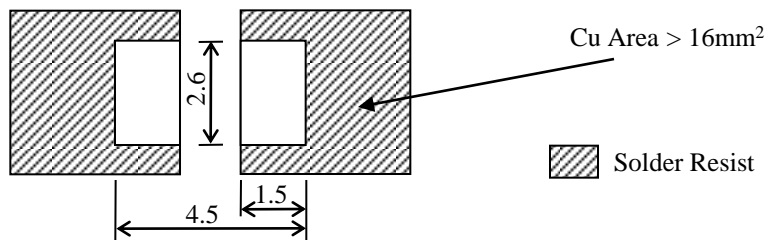

7) Recommendable Soldering Pattern (for Double Wave Soldering)

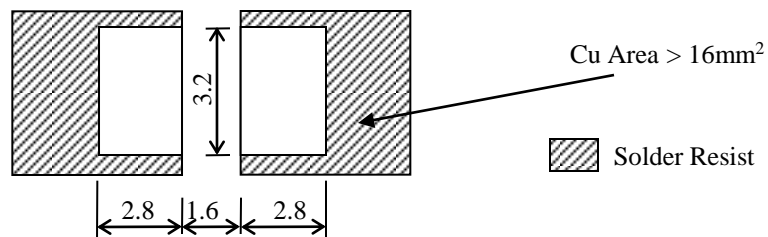

8) Precaution When Mounting

Do not apply force to the plastic part of the LED under high-temperature conditions.
 To avoid damaging the LED plastic do not apply friction using hard materials.
 When installing the PCB in product, ensure that the device does not come into contact with other components

9) Recommended Circuit model

- A) Recommended Circuit
 B) The difference of brightness between the LEDs could be found due to the V_F characteristics of each LED.

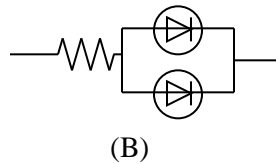
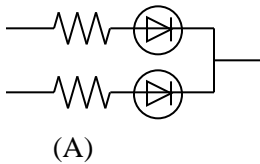

10) Recommended Operating Current

Operating current is optimized on test conditions of grouping parameter.
 We recommend the operating current of each LED more than 2mA.
 If the LED must be operated less than 2mA, special care should be taken to insure that the intensity of illumination is not uniformed by deviation of the I_F upon low operating voltage.

11) Recommended Mounting Direction

Mount the LED in longitudinal direction of the board so that stress on product is decreased.
 We recommend the LED be placed on the PC Board as shown diagram A.
 If the LED must be placed on the PC Board as shown in diagram B, special care should be taken to insure that the LED is not effected by bend of the PC Board after the soldering process.

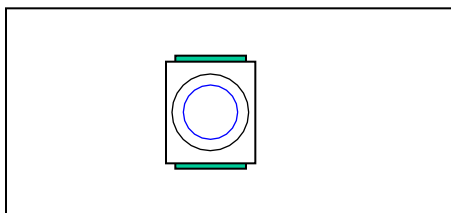

(A)

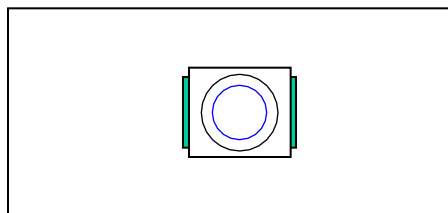

(B)

8. Packing Process and Materials

1) Dimension of tape (Material : PS Conductive, 10E4~5Ω)

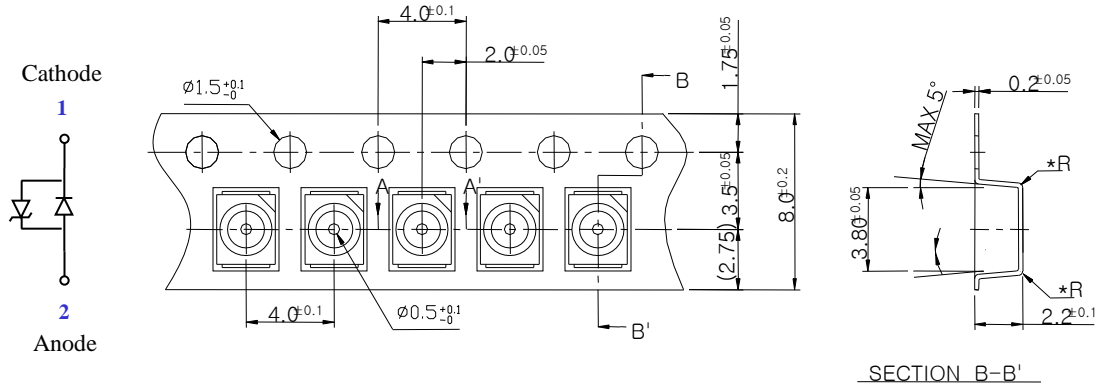

2) Details of Chip LEDs loading on tape

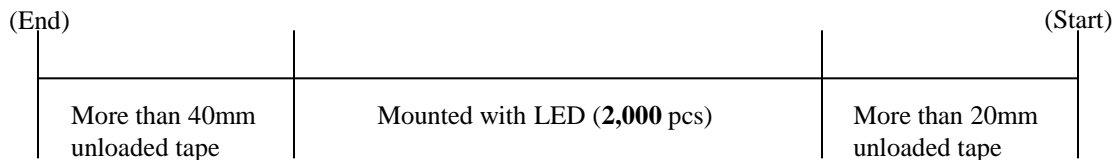

3) Dimension of Reel (Material : PS Conductive, 10E9~12Ω)

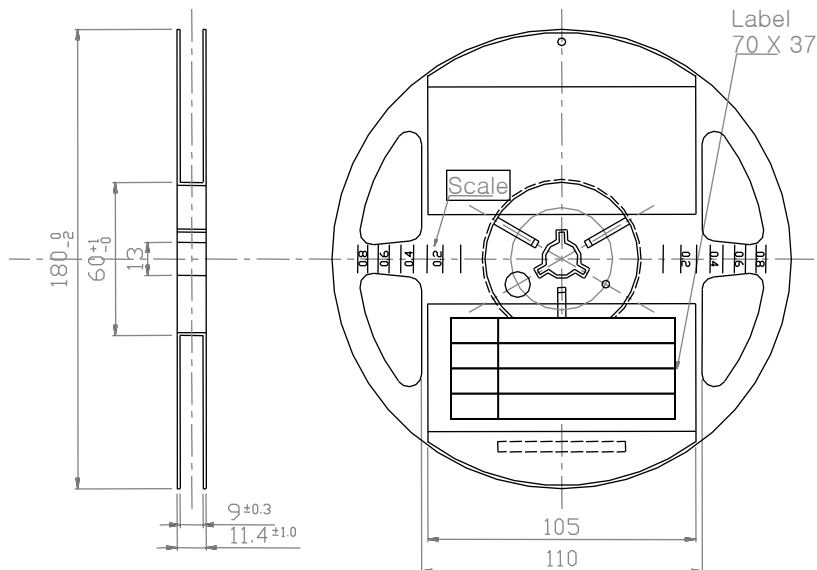

- (1) Quantity : Product are packed in one taping reel of max. **2,000** pcs.
- (2) Cumulative Tolerance : Cumulative Tolerance/10 pitches to be $\pm 0.2\text{mm}$
- (3) Adhesion Strength of Cover Tape : Adhesion strength to be 0.1-0.7N when the cover tape is turned off from the carrier tape at 10° angle to be the carrier tape.
- (4) Packaging : P/N, Manufacturing data Code No. and quantity to be indicated on a damp proof Package.

Spec No.	Ver.	Date	Page
T3528HM-203	0.0	2011/02/14	<#>/ 15

4) Packing Structure

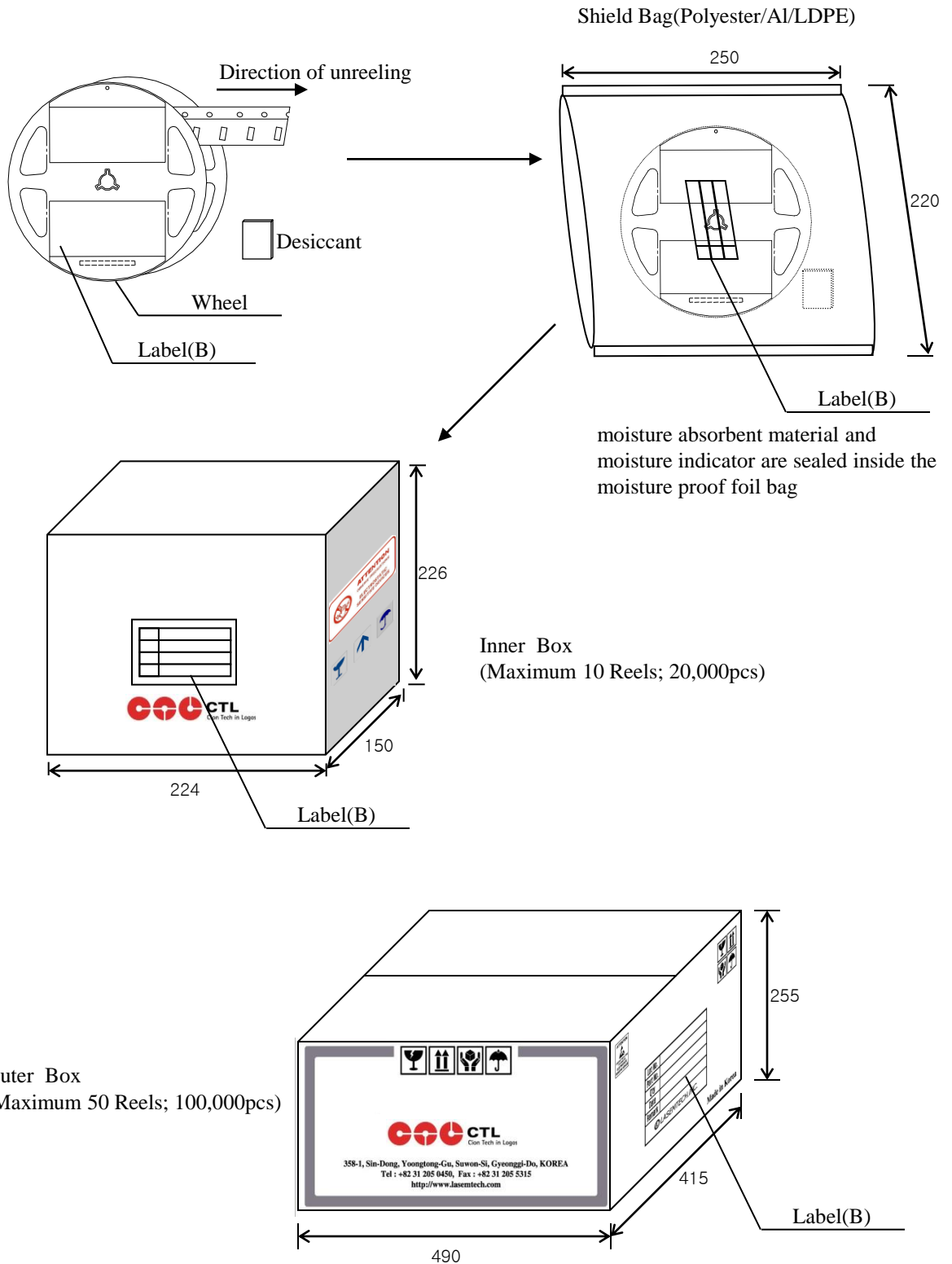

5) Labeling

Type1.

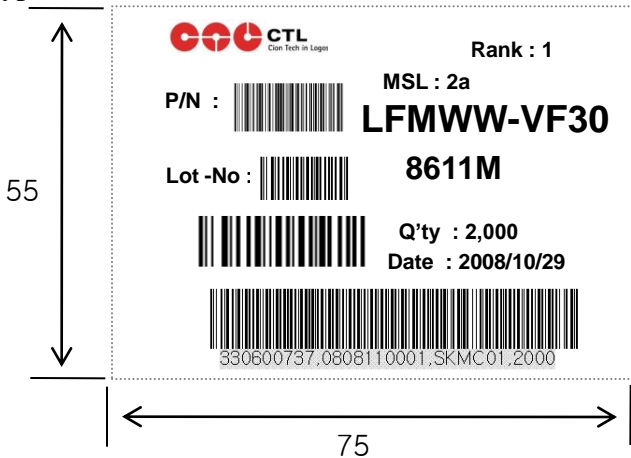

- Electrical/Optical Rank
- Product Code (Bar Code)
- Lot No (Bar Code)
- Reel Serial No
- Quantity (Bar Code)
- Packing Date(Bar Code)
- Customer Special (Bar Code)

Type2.

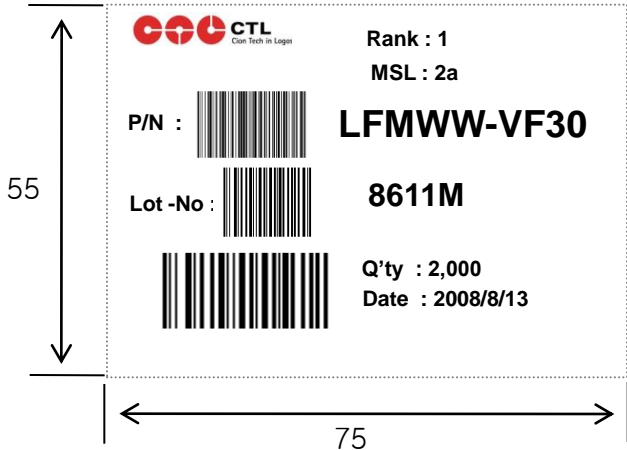

- Electrical/Optical Rank
- Product Code (Bar Code)
- Lot No (Bar Code)
- Reel Serial No
- Quantity (Bar Code)
- Packing Date(Bar Code)

Type3.

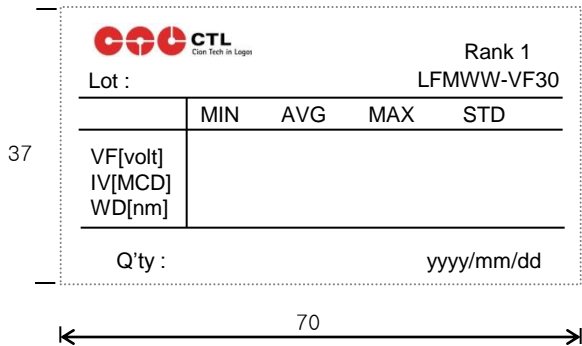

- Property Rank Number
- Reel No & CTL's P/N
- Electrical/Optical property Data
- Quantity & packing Date

9. Reliability

1) The reliability Criteria of SMD LED

Items	Symbol	Test Conditions	Criteria for Judgement	
			Min.	Max.
Forward Voltage	V_F	$I_F=20mA$	-	U.S.L.*) $\times 1.1$
Luminous Intensity	I_V	$I_F=20mA$	L.S.L.**) $\times 0.7$	-

□ *) U.S.L. : Upper Standard Level

***) L.S.L. : Lower Standard Level

2) Results of reliability test

Test Items	Reference	Test Conditions	Note
High Temperature Storage	JEITA ED-4701 200 201	100 °C / 1,000 hr.	0/32
Low Temperature Storage	JEITA ED-4701 200 202	-40 °C / 1,000 hr.	0/32
Temp. Humidity Storage	JEITA ED-4701 100 103	60 °C / 90 % RH / 1,000 hr.	0/32
Steady State Operating Life	EIA/JESD22- A108-B	25 °C / 20 mA / 1,000 hr.	0/32
High Temperature Operating Life	EIA/JESD22- A108-B	85 °C / 10 mA / 1,000 hr.	0/32
Low Temperature Operating Life	EIA/JESD22- A108-B	-40 °C / 20 mA / 1,000 hr.	0/32
Steady State Operating life of High Humidity Heat	JEITA ED-4701 100 102	60 °C / 90 % RH / 20 mA 1,000 hr.	0/32
Temperature Cycle	JEITA ED-4701 100 105	-40°C(30min) → 25(5min.) → 100(30min.) / 100 cycle	0/22
ElectroStatic Discharge	EIA/JESD 22- A114-A: Class 2	HBM : 100pF / 1.5kohm > $\pm 2KV$ / 3 times	0/22

10. Precaution for use

- This device should not be used in any type of fluid such as water, oil, organic solvent, etc.
When washing is required, IPA should be used.
- When the LEDs are illuminating, operating current should be decided after considering the ambient maximum temperature.
- LEDs must be stored to maintain a clean atmosphere.
If the LEDs are stored for 3months or more after being shipped from CTL, a sealed container with a nitrogen atmosphere should be used for storage.
- After opening the moisture proof packing, the LED's should be kept at 5°C~30°C, 60%RH or below.
The LEDs must be soldered within 4 Weeks(672 hours) after opening the moisture-proof packing.
If the LEDs remains after soldering, it should be stored into moisture proof container.
- Repack unused Products with anti-moisture packing, fold to close any opening and then store in a dry place.
- If upon opening, the moisture indicator card shows humidity 30% or above (Color of indication changes to pink) or the expiration date has passed, the device should be baked in taping with reel using the conditions of $65 \pm 5^{\circ}\text{C}$, 12~24hours.
After baking, use the baked devices within 72hours, but perform baking only once.
- Repeated baking can cause the peeling strength of the taping to change, then leads to trouble in mounting. Furthermore, prevent the devices from being destructed against static electricity for baking of it.
- The appearance and specifications of the product may be modified for improvement without notice.
- If the packing material of laminate would be broken, the hermeticity would deteriorate. Therefore, do not throw or drop the packed devices..
- This LEDs is sensitive to the electrostatic and surge,
It is recommended to use a wrist band or anti-electrostatic glove when handling the LEDs.
- If over-voltage which exceeds the absolute maximum rating is applied to LEDs, It will cause damage LEDs and result in destruction.
- Damaged LEDs will show unusual characteristics such as leak current remarkably increase, turn-on voltage becomes lower and the LEDs get unlight at low current.
- It is better not to use different rank LEDs.
If use mixed rank, could not attain your object for highest quality of products.