

# RI-60 SMD Series Dry Reed Switch

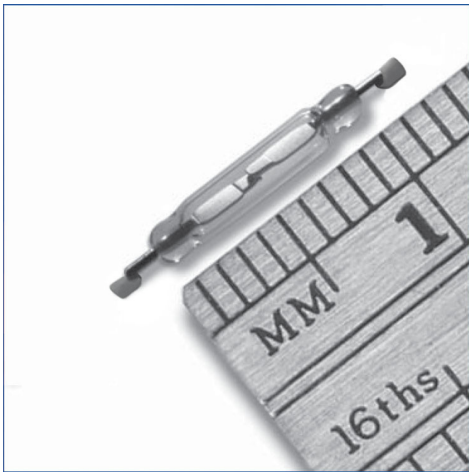

## RI-60 SMD Series

Ultra-miniature dry-reed switch hermetically sealed in a gas-filled glass envelope. Single-pole, single-throw (SPST) type, having normally open contacts, and containing two magnetically actuated reeds.

The switch is of the double-ended type and may be actuated by an electromagnet, a permanent magnet or a combination of both. The device is intended for use in relays, sensors, pulse counters or similar devices.

## RI-60 SMD Series Features

- Ideal for ATE switching
- Contact layers: gold, sputtered ruthenium
- Superior glass-to-metal seal and blade alignment
- Excellent life expectancy and reliability
- RoHS Compliant

## Dimensions for RI-60 SMD Series *All Dimension in inches (mm) nominal*

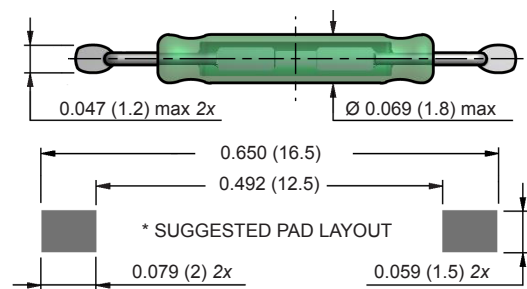
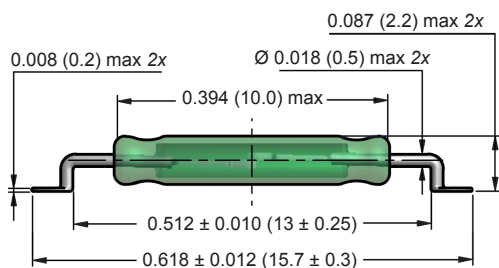

\* For other pad layouts please contact us.

## Technical Specifications

Parameters	Test Conditions	Units	RI-60
<b>Operating Characteristics</b>			
Operate Range		AT	7-21
Release Range		AT	3 (min)
Operate Time - including Bounce (typ.)		ms	0.15
Bounce Time (typ.)		ms	0.035
Release Time (max)		µs	20
Resonant Frequency (typ.)		Hz	11300
<b>Electrical Characteristics</b>			
Switched Power (max)		W	10
Switched Voltage DC (max)		V	200
Switched Voltage AC, RMS value (max)		V	140
Switched Current DC (max)		mA	500
Switched Current AC, RMS value (max)		mA	500
Carry Current DC (max)		mA	500
Breakdown Voltage (min)		V	230
Contact Resistance (initial max.)		mΩ	125
Contact Resistance (initial typ.)		mΩ	95
Contact Capacitance (max)	without test coil	pF	0.25
Insulation Resistance (min)	RH ≤ 45%	MΩ	10 <sup>6</sup>

# RI-60 SMD Series Dry Reed Switch

## Based on standard RI-60 models

### ORDERING INFORMATION

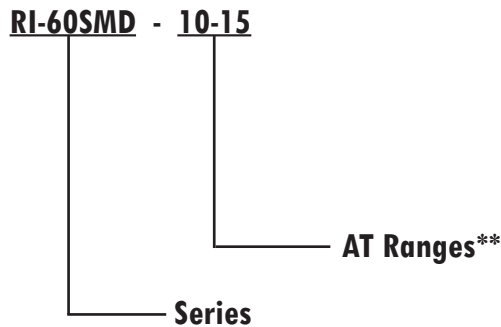

*\*\*Customer specific AT ranges are possible. Please contact your local sales representative.*

#### Coils

All characteristics are measured using the Philips Standard Coil. For definitions of the Philips Standard Coil, refer to “Application Notes” in the *Reed Switch Technical & Application Information* Section of this catalog.

#### Life expectancy and reliability

The life expectancy data given below are valid for a coil energized at 1.25 times the published maximum operate value for each type in the RI-60 series.

#### No load conditions (operating frequency: 100Hz)

Life expectancy: min.  $10^9$  operations with a failure rate of less than  $2 \times 10^{-10}$  with a confidence level of 90%.

End of life criteria:

- Contact resistance  $> 1\Omega$  after 2 ms
- Release time  $> 2$  ms (latching or contact sticking).

#### Loaded conditions (resistive load: 5 V; 100 mA; operating frequency: 125 Hz)

Life expectancy: min.  $2 \times 10^7$  operations with a failure rate of less than  $10^{-8}$  with a confidence level of 90%.

End of life criteria:

- Contact resistance  $> 1\Omega$  after 2.5 ms
- Release time  $> 1$  ms (latching or contact sticking).

#### Loaded conditions (resistive load: 20 V; 500 mA; operating frequency: 125 Hz)

Life expectancy: min.  $2 \times 10^7$  operations with a failure rate of less than  $10^{-8}$  with a confidence level of 90%.

End of life criteria:

- Contact resistance  $> 2\Omega$  after 2.5 ms
- Release time  $> 2.5$  ms (latching or contact sticking).

Switching different loads involves different life expectancy and reliability data. Further information is available on

request.

#### Mechanical Data

Contact arrangement is normally open; lead finish is tinned; net mass is approximately 90mg; and can be mounted in any position.

#### Shock

The switches are tested in accordance with “IEC 68-2-27”, test Ea (peak acceleration 100 G, half sinewave; duration 11 ms). Such a shock will not cause an open switch (no magnetic field present) to close, nor a switch kept closed by an 80 AT coil to open.

#### Vibration

The switches are tested in accordance with “IEC 68-2-26”, test Fc (acceleration 10G; below cross-over-frequency 57 to 62 Hz; amplitude 0.75 mm; frequency range 10 to 2000 Hz; duration 90 minutes.) Such a vibration will not cause an open switch (no magnetic field present) to close, nor a switch kept closed by an 80 AT coil to open.

#### Mechanical Strength

The robustness of the terminations is tested in accordance with “IEC 68-2-21”, test Ua1 (load 10 N).

#### Operating and Storage Temperature

Operating ambient temperature; min:  $-55^\circ\text{C}$ ; max:  $+125^\circ\text{C}$ . Storage temperature; min:  $-55^\circ$ ; max:  $+125^\circ\text{C}$ . Note: Temperature excursions up to  $150^\circ\text{C}$  may be permissible. For more information contact your nearest Comus Group sales office.

#### Soldering

The switch can withstand soldering heat in accordance with “IEC 68-2-20”, test Tb, method 1B: solder bath at  $350 \pm 10^\circ\text{C}$  for  $3.5 \pm 0.5$  s. Solderability is tested in accordance with “IEC 68-2-20” test Ta, method 3: solder globule temperature  $235^\circ\text{C}$ ; ageing 1b: 4 hours steam.

#### Through-hole Reed Switches

The attachment method is typically eutectic soldering. RoHS requires solder with no elemental lead (Pb). SAC alloy (96,5Sn / 3AG / 0,5Cu) is the most popular choice. Reed switches can be soldered by hand or by wave solder processing. Comus Technology recommends the maximum wave solder temperature (measured at the reed switch leads) as  $270^\circ\text{C}$  for 10 seconds. Temperature and time in excess of the recommended levels may result in damage to the reed switch. All of our through-hole reed switches will be compatible with either SAC alloy or eutectic soldering process.

# RI-60 SMD Series Dry Reed Switch

## Surface Mounted Reed Switches

The most common method of attachment is by SMD processing - stencil/screen solder paste, then oven reflow. Due to board thickness, component density, and other circumstances that dictate the required reflow temperature, Comus Technology uses a higher temperature solder for all internal connections. We recommend that the temperature (measured at the reed switch leads) does not exceed 260°C for 1 minute. Temperature and time in excess of the recommended levels may result in damage to the reed switch.

## Handling Force

When possible don't add pressure on the glass on placing

the reed switch on a pcb or device. However when handling with a Pick and Place machine the acceptable force on the reed switch is 3N with a max of 5N.

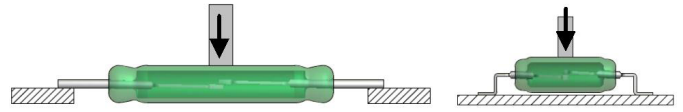

\* As part of the company policy of continued product improvement, specifications may change without notice. Our sales office will be pleased to help you with the latest information on this product range and the details of our full design and manufacturing service. All products are supplied to our standard conditions of sale unless otherwise agreed in writing.

## Recommended Soldering Reflow Profile

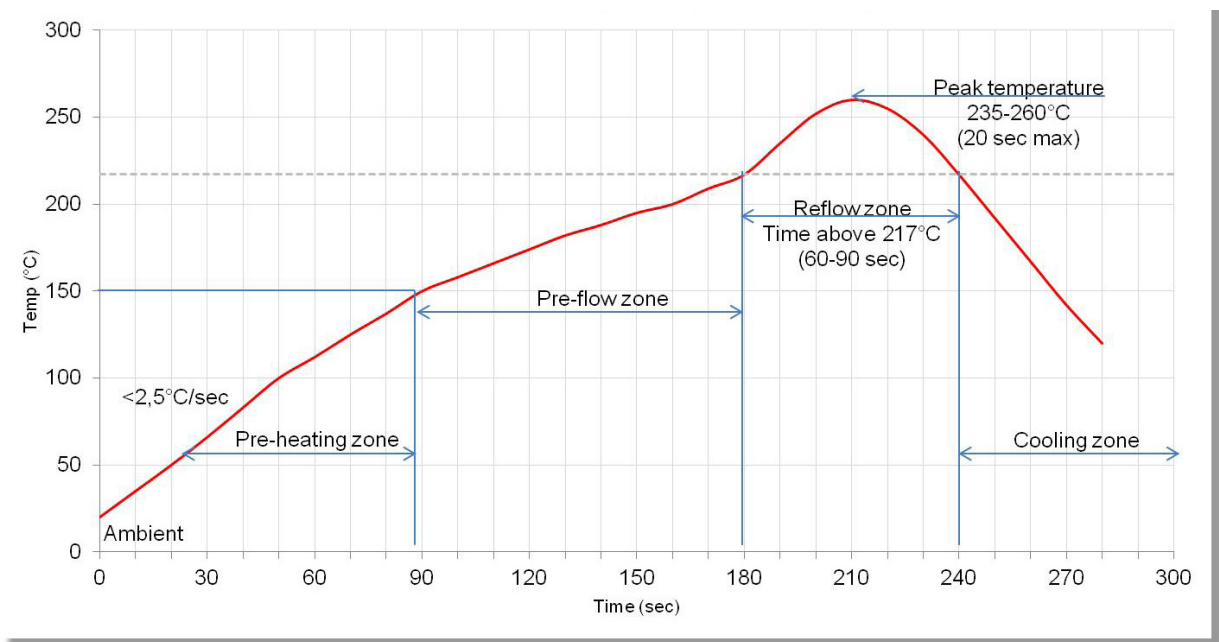

## Dimensions for RI-60 SMD Tape and Reel

All Dimension in inches (mm) nominal

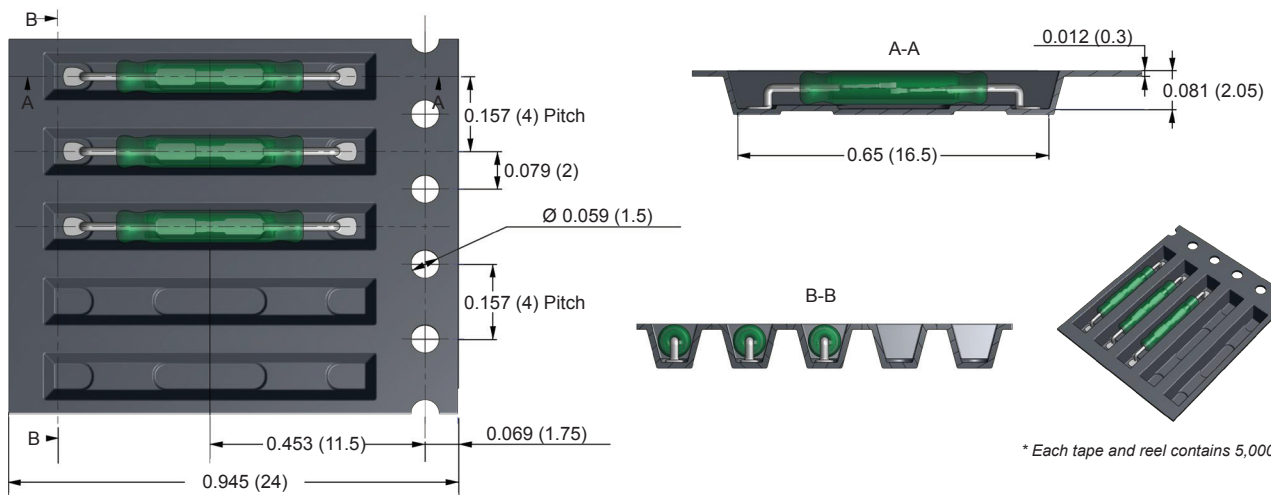

\* Each tape and reel contains 5,000 pieces.

# RI-60 SMD Series Dry Reed Switch



Comus International  
454 Allwood Road  
Clifton, New Jersey 07012  
U.S.A

Tel: (1)973 - 777 - 6900  
Fax: (1)973 - 777 - 8405  
email: [info@comus-intl.com](mailto:info@comus-intl.com)  
Website: <http://www.comus-intl.com>  
ISO 9001:2008  
CERTIFICATE NO: 03-12314



Comus Europe Ltd  
Unit 7, Rice Bridge Industrial Estate  
Thorpe - Le - Soken  
Essex, England  
CO160HL  
Tel: +44 (0)1255 862236  
Fax: +44 (0)1255 862014  
email: [sales@comuseurope.co.uk](mailto:sales@comuseurope.co.uk)  
Website: <http://www.comuseurope.co.uk>  
ISO 9001:2008  
CERTIFICATE NO: FM 21080



Comus Belgium BVBA  
Overhaamlaan 40  
B-3700 Tongeren  
Belgium

Tel: +33 (0)12 390400  
Fax: +33 (0)12 235754  
email: [info@comus.be](mailto:info@comus.be)  
Website: <http://www.comus.be>



Comus Technology BV  
Jan Campertstraat 11  
6416 SG Heerlen  
The Netherlands

Tel: +31(0)45 5439345  
Fax: +31(0)45 5427216  
email: [info@comus-intl.com](mailto:info@comus-intl.com)  
Website: <http://www.dry-reeds.com>



Comus Electronics and Technologies  
India Private Limited  
2nd Floor, No.31/33, Anjugam Nagar  
2nd Street, Ashok Nagar, Jaferkhanpet  
Chennai 600083  
Tamil Nadu, India  
Tel:+(91)-(44)-42023510  
Fax:+(91)-(44)-22628198  
email: [info@comus-intl.com](mailto:info@comus-intl.com)  
Website: <http://www.comusindia.com>

## TAKE A LOOK AT OUR VARIETY OF PRODUCTS



Float Switches



Acceleration / Shock Switches



Movement Sensors



Tilt / Tip Switches



Reed Relays



Solid State Relays



High Breakdown Switches



Reed Switches



Magnets



Smart Sensors



Optical Level Switches



Alarm / Security Switches